

Parks and Recreation Department

# Balboa Park Restroom Project Workshop Item

Balboa Park Committee  
January 11, 2024



## Balboa Park Restroom Project Scope

- Palisades Restroom
- Organ Pavilion Restroom
- Spanish Village Men's Restroom
- Village Place Restroom
- Morley Field Restroom

# Balboa Park Restroom Project Scope

- ADA Compliance
- Gender-Neutral Facilities
- Safety and Security
- Renovation where warranted
- Reconstruction where warranted

# Balboa Park Restroom Locations

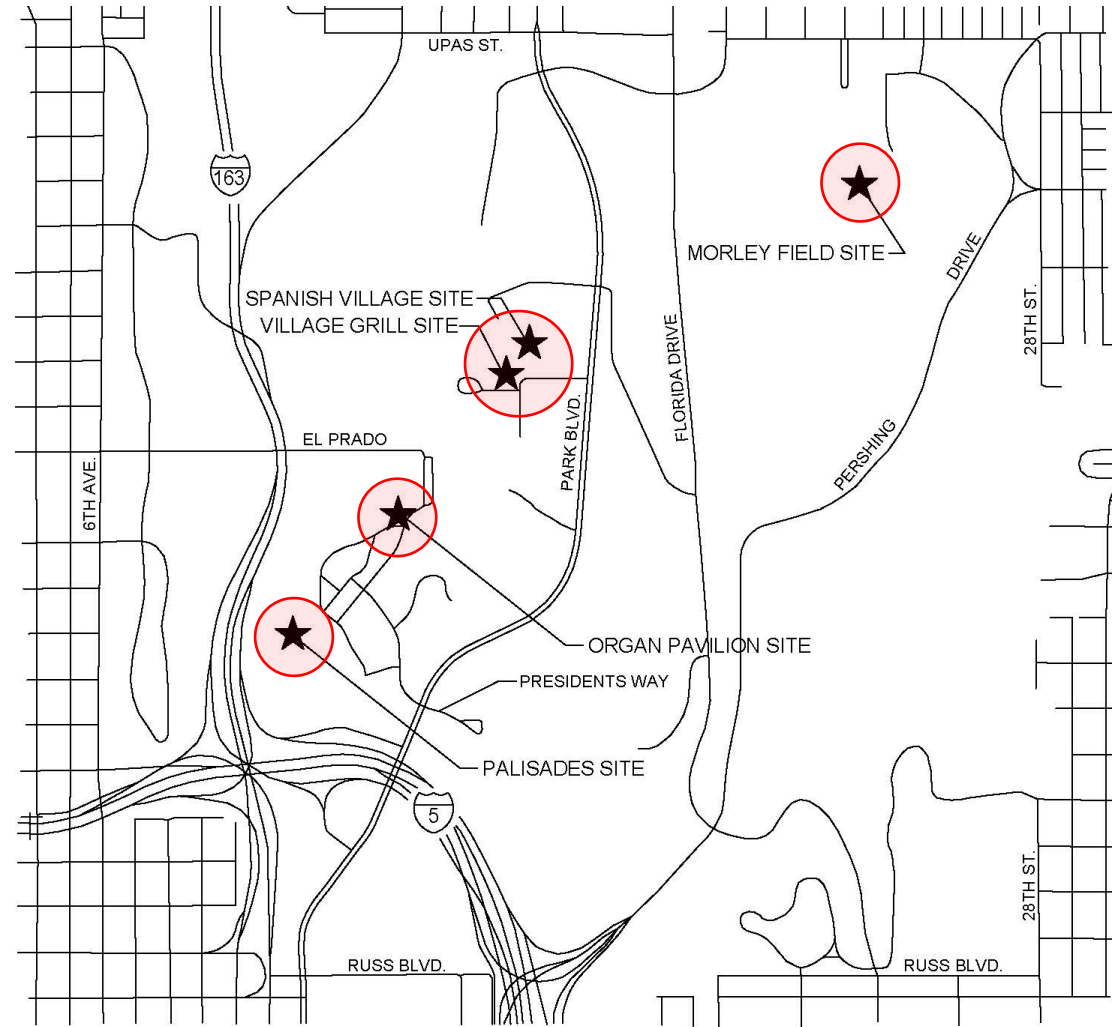

## Informational Updates

- Palisades Restroom
- Organ Pavilion Restroom
- Spanish Village Men's Restroom

## Palisades Restroom

- Revised Scope of Work
- Renovate existing restroom to be Ranger station and/or Visitor Center
- Construct new gender neutral restroom facilities



## 7. Plaza de las Americas

### Design Objective:

Restore the southern portion of the 1935 Plaza area of the Palisades to its original use as a pedestrian plaza. This plaza should function as a pleasant southern destination point for the Central Mesa and offer amenities that will serve the needs of a variety of user groups from nighttime playgoers to museum patrons who might spend half a day in the immediate area. It should provide pooling space for the Starlight Bowl areas for outdoor display, circulation space, food service, visitor information, public restrooms, a variety of seating, and visual interest features that will invite the Park visitor to pause, relax, and enjoy spending time outdoors.

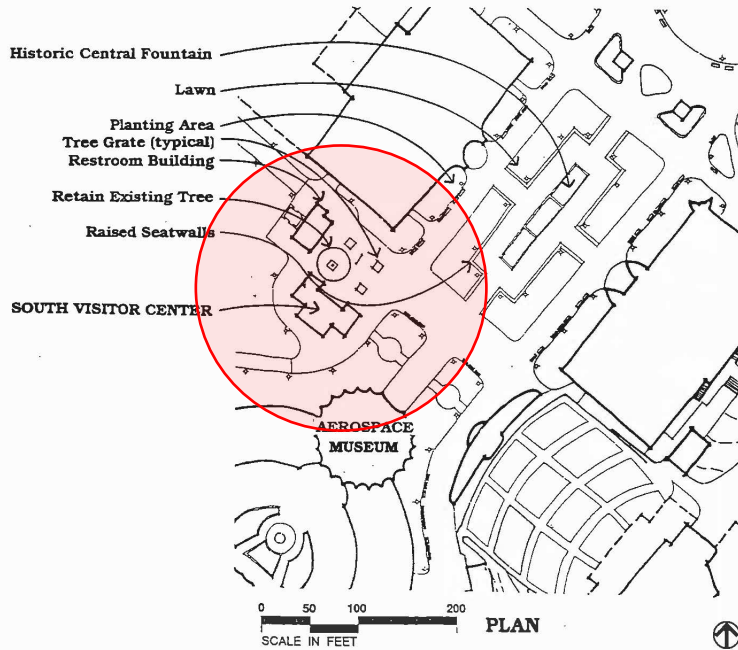

**Historic Central Fountain**

**Lawn**

**Planting Area**  
**Tree Grate (typical)**  
**Restroom Building**

**Retain Existing Tree**

**Raised Seatwalls**

**SOUTH VISITOR CENTER**

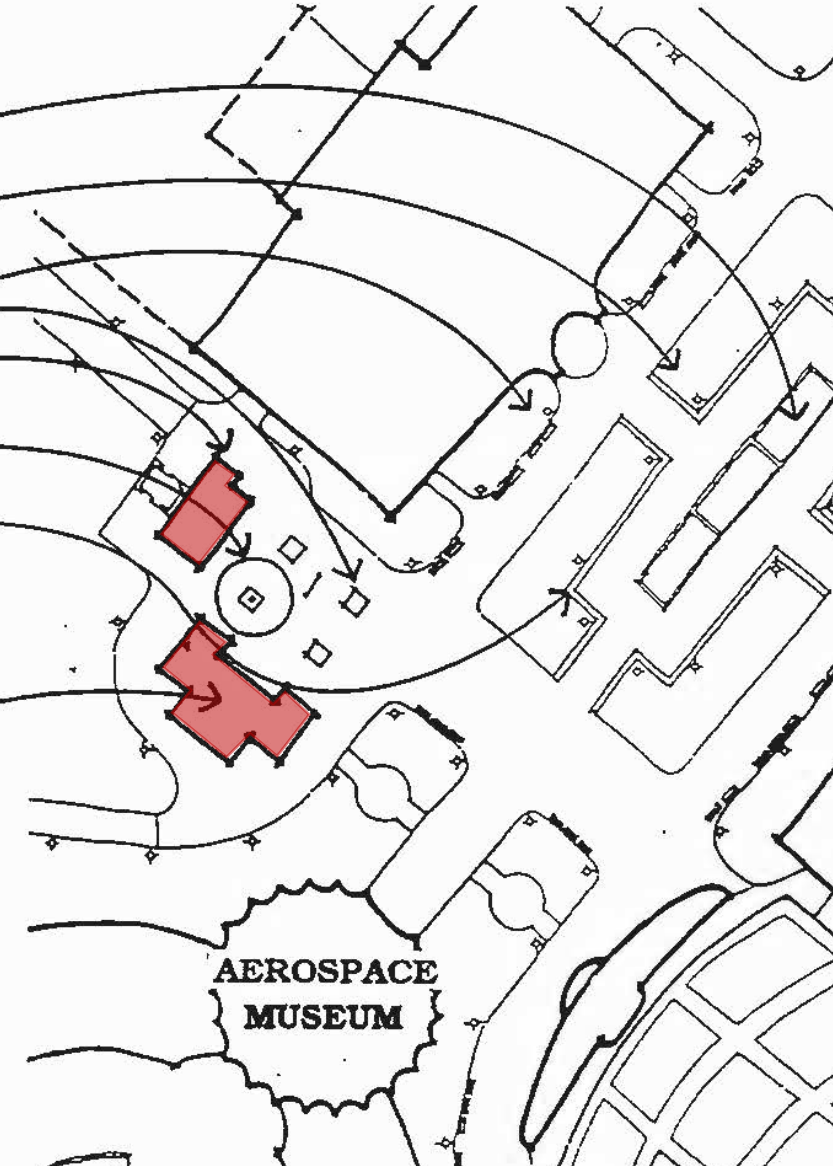

## Palisades Restroom

- Consistent with Precise Plan
- Preserves historic building
- Provides new gender-neutral restroom facilities
- Project to be transferred to Engineering & Capital Projects Department for community input and implementation



# Organ Pavilion Restroom

- Revised Scope of Work
- Renovate existing restrooms in their current configuration with new fixtures and finishes
- Project to be transferred to Engineering and Capital Projects Department for community input and implementation



## Spanish Village Men's Restroom

- Renovate existing men's restroom with new fixtures and finishes
- Women's restroom already upgraded
- Project to be transferred to Engineering and Capital Projects Department for community input and implementation
- To be "packaged" with Organ Pavilion Restroom

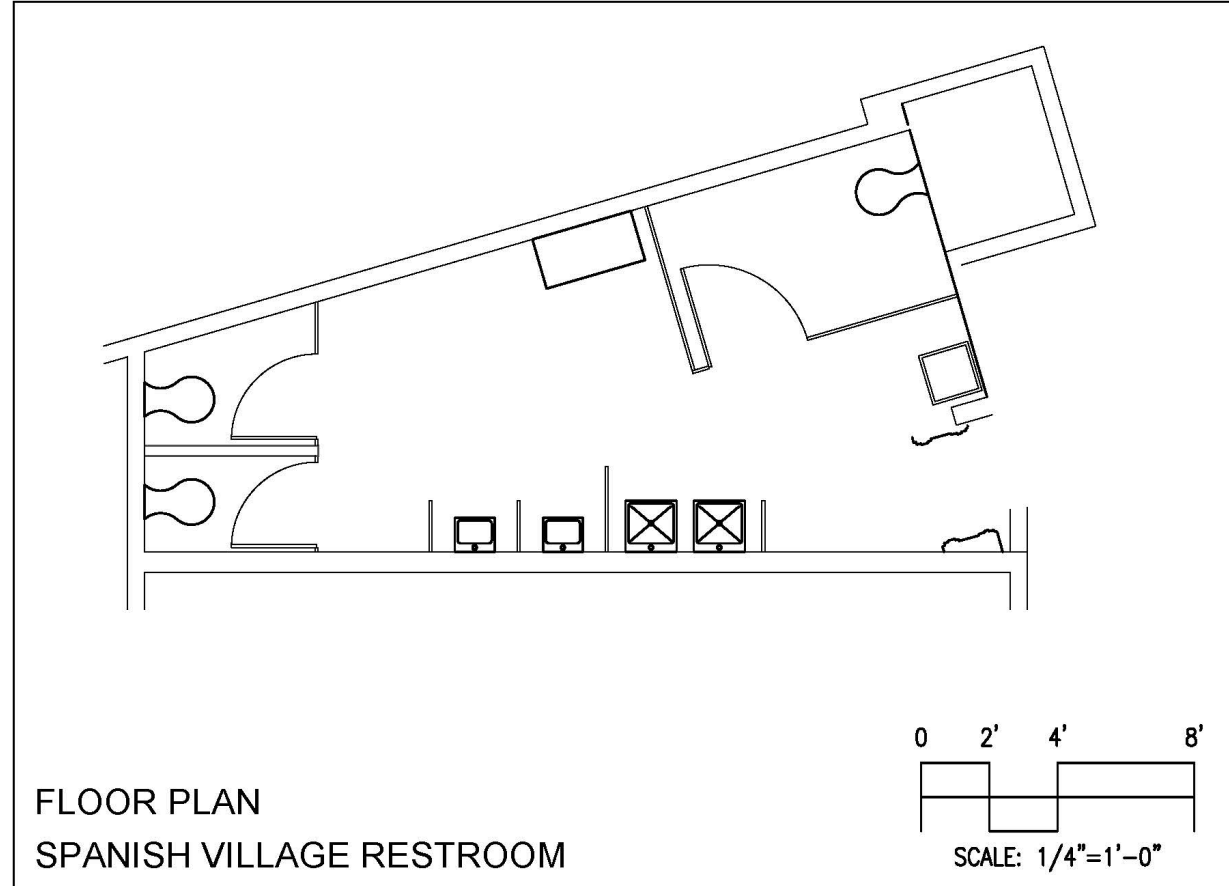

## Workshop Items

- Village Place Restroom
- Morley Field Restroom

# Village Place Restroom

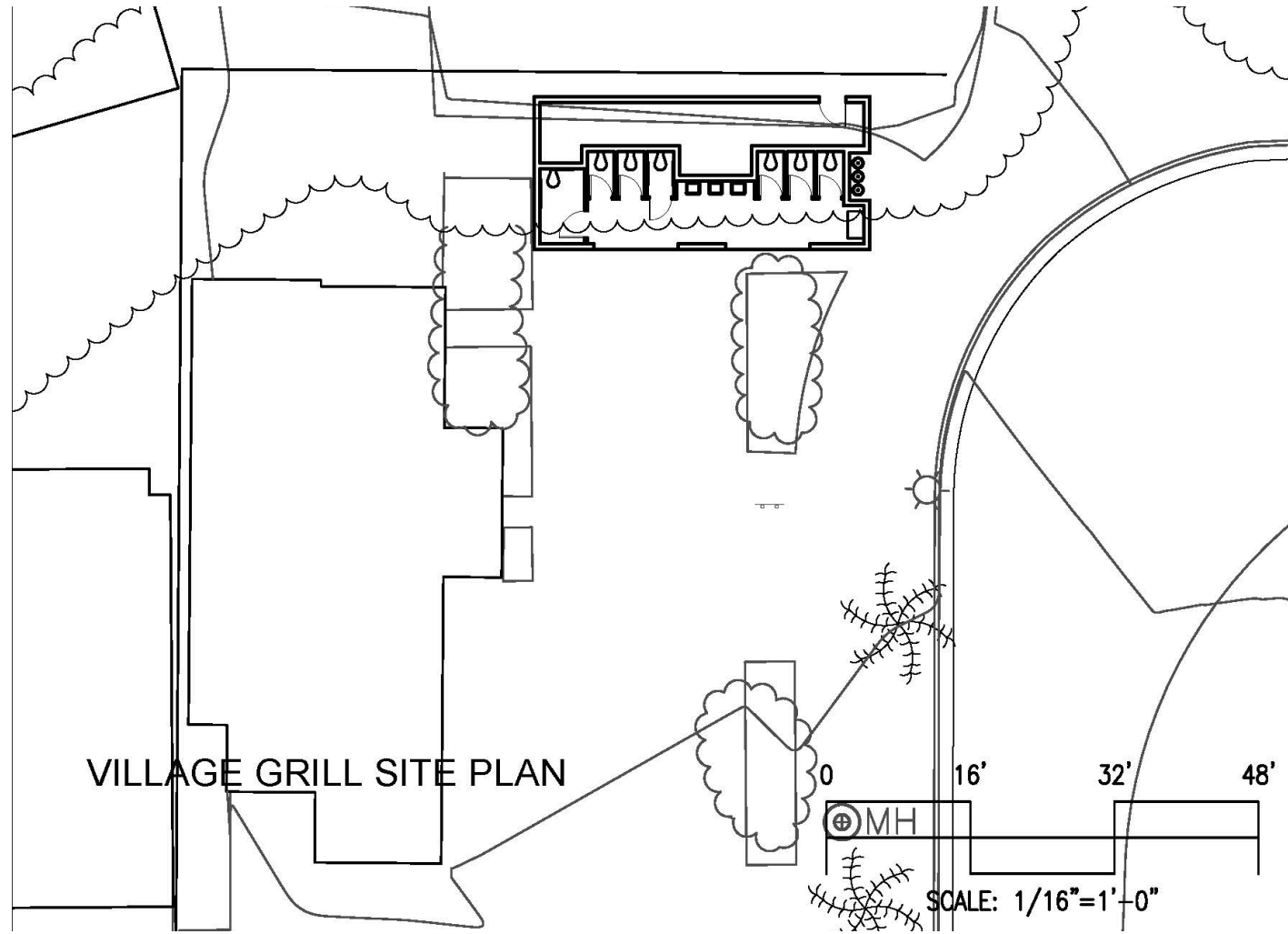

# Village Place Restroom

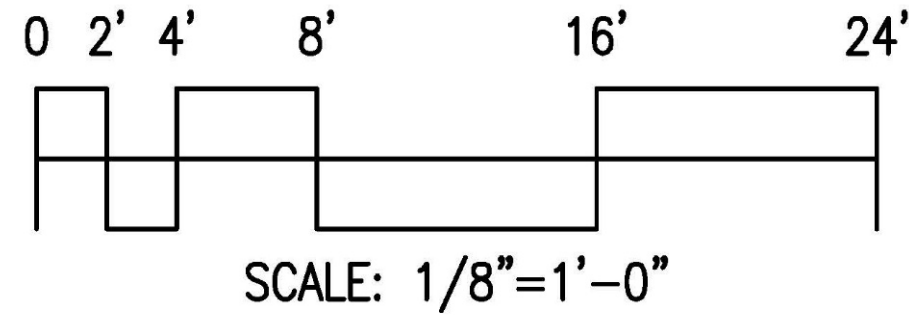
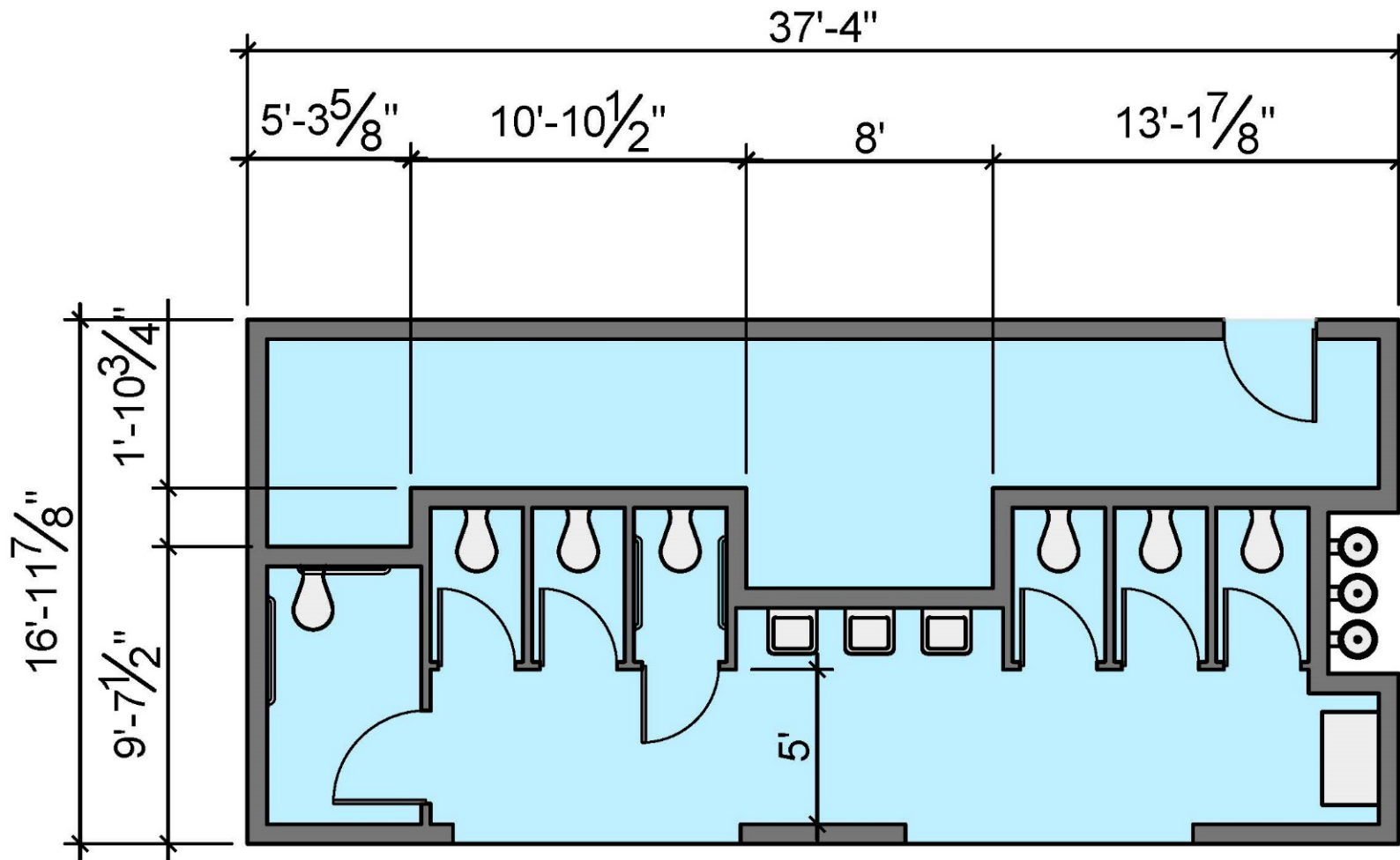

# Village Place Restroom

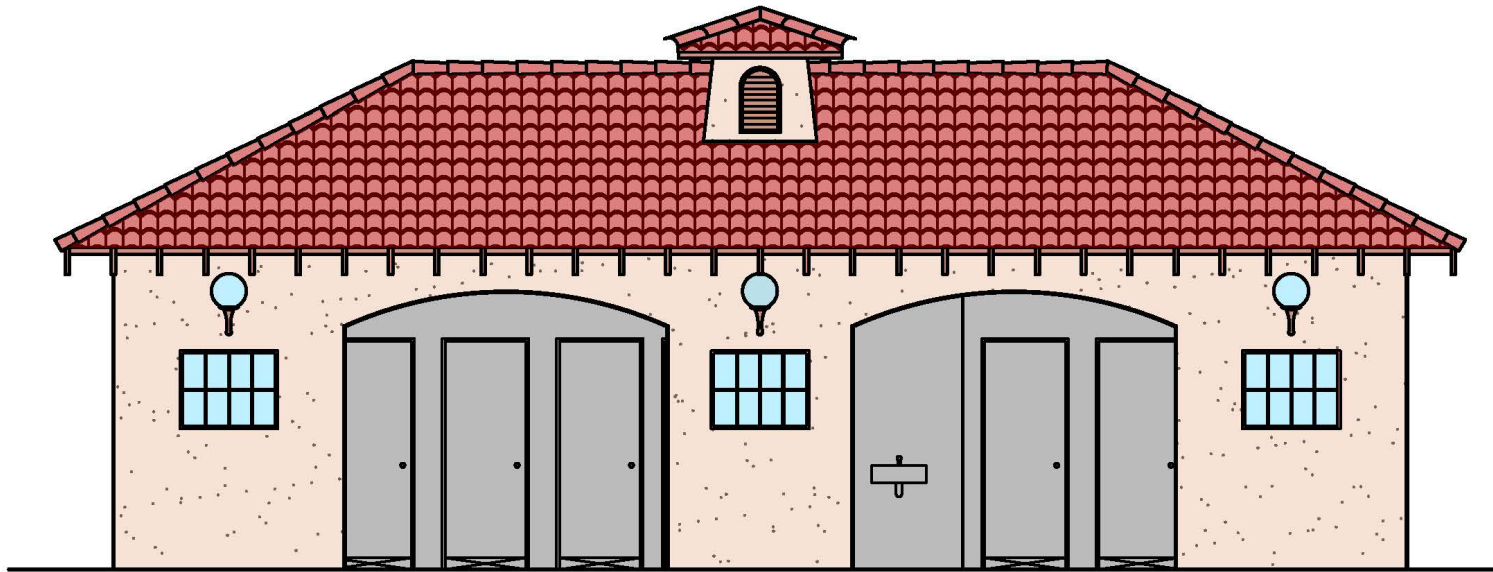

SOUTH ELEVATION

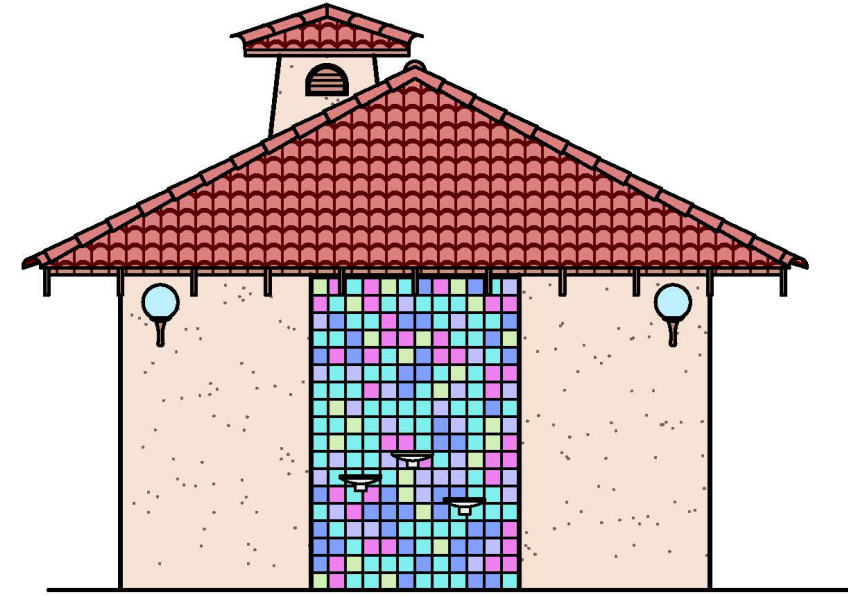

EAST ELEVATION

# Village Place Restroom

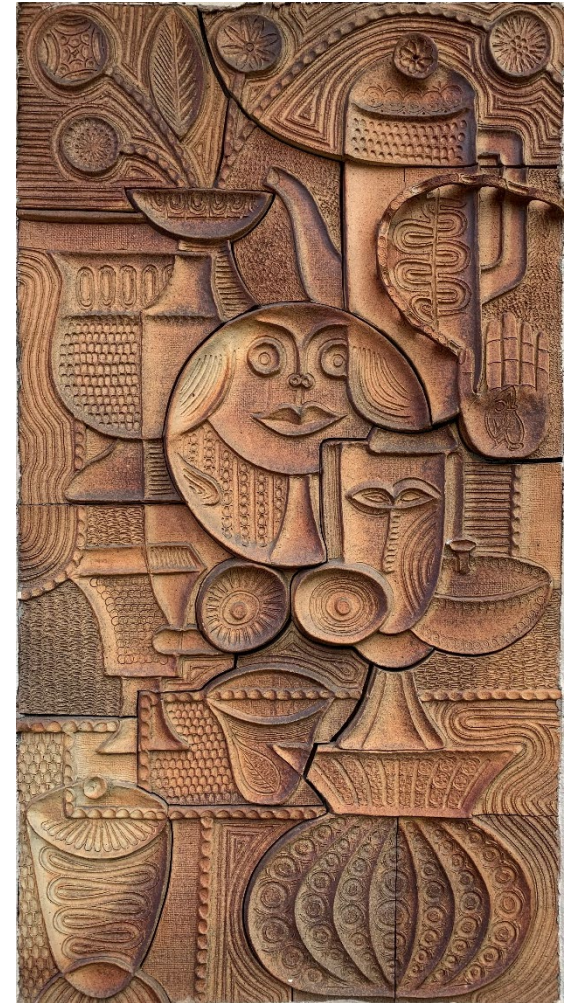

# Morley Field Restroom

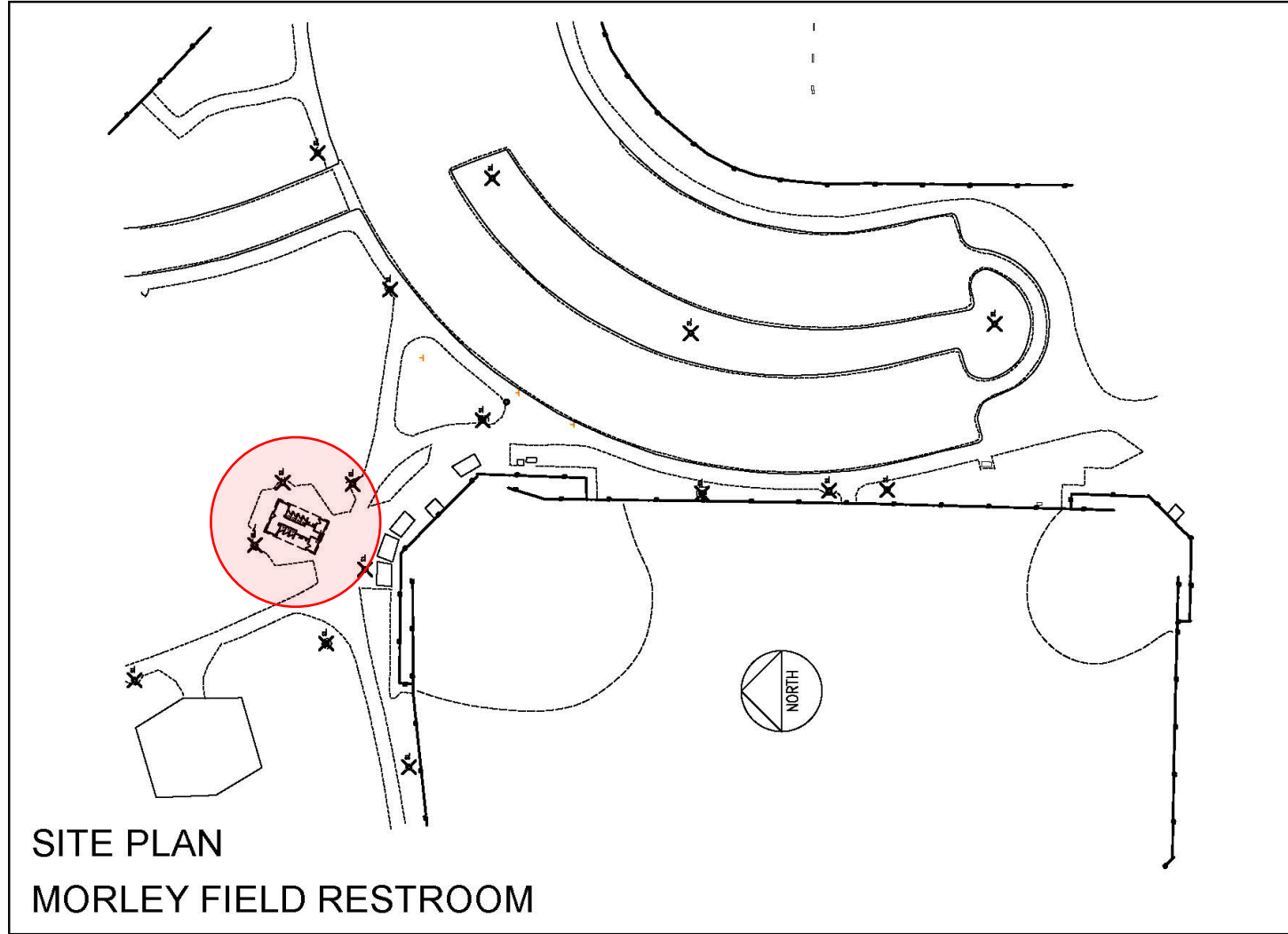



# Morley Field Restroom

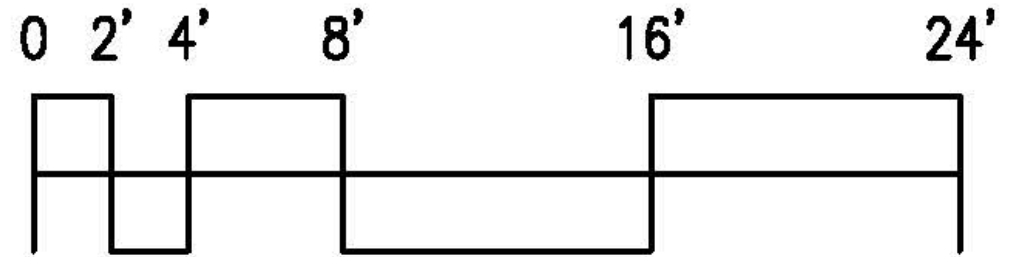
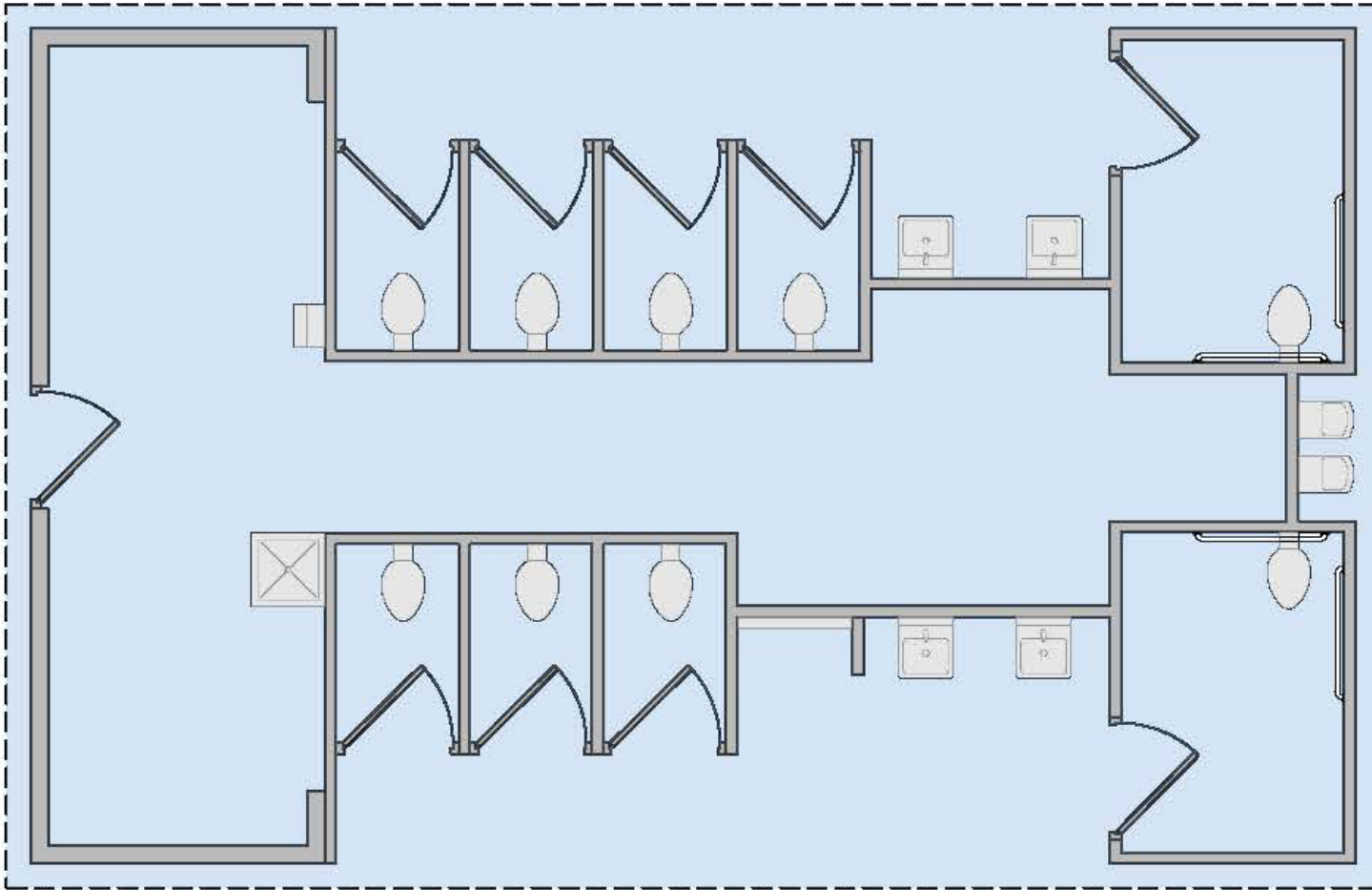

# Morley Field Restroom

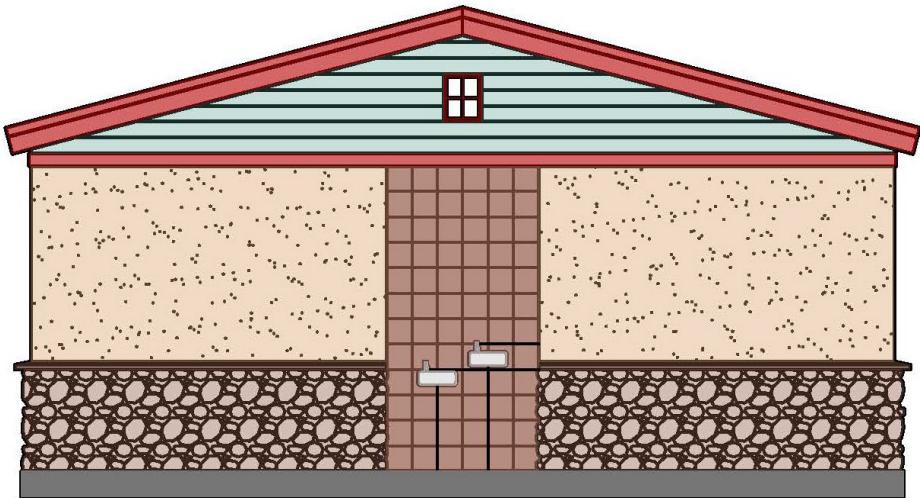

Parks and Recreation Department

Discussion/Workshop